

# DEVELON

## Crawler Excavator

# DX300LC-7



### Engine

Make	DEVELON
Model	DL08-LEE04
Number of cylinders	6
Rated power, gross (hp per SAE J1995)	270.1 hp (202.3 kW) @ 1800 rpm
Rated power, net (hp per SAE J1349)	266.9 hp (199.0 kW) @ 1800 rpm
Max. torque, gross (SAE J1995)	940.3 ft.-lb. (1275.0 Nm) @ 1300 rpm
Displacement	463.8 in. <sup>3</sup> (7.6 L)
Bore and stroke	4.3" x 5.5" (108 mm x 139 mm)
Starter	24 V, 8.0 hp (6.0 kW)
Battery	2 x 12 V, 150 AH
Alternator	24 V, 80 A
Air cleaner	Three-stage

### Hydraulics

Main pumps	2 x 76.1 gpm (2 x 288.0 L/min.)
Pilot pump (gear design)	7.1 gpm (27.0 L/min.)

### Working Pressure

Boom/arm/bucket (normal mode)	4980.0 psi (350.0 kg/cm <sup>2</sup> )
Boom/arm/bucket (power boost)	5260.0 psi (370.0 kg/cm <sup>2</sup> )
Travel	4980.0 psi (350.0 kg/cm <sup>2</sup> )
Swing	4200.0 psi (295.0 kg/cm <sup>2</sup> )
Pilot	586.0 psi (40.8 kg/cm <sup>2</sup> )

### Undercarriage

Upper rollers (each track)	2
Lower rollers (each track)	9
Number of shoes (links per side)	48

### Swing Mechanism

Swing speed	0 - 9.6 rpm
Swing torque	87787.0 lbf.ft. (12137.0 kgf-m)

### Drive System

Travel speed (low - high)	1.9 - 3.4 mph (3.0 - 5.5 km/h)
Traction force, max. (drawbar pull)	77161.0 lbf. (35000.0 kgf)
Max. grade (limited by engine lub)	70% (35°)

### Environment

Sound level (2000/14/EC)	105 dB(A)
Cabin sound level (ISO 6396)	71 dB(A)

### Refill Capacities

Fuel tank	129.4 gal. (490.0 L)
DEF tank	16.4 gal. (62.0 L)
Cooling system (radiator capacity)	15.5 gal. (58.7 L)
Engine oil (with filter)	11.1 gal. (42.0 L)
Swing drive	1.8 gal. (7.0 L)
Final drive (each side)	1.8 gal. (7.0 L)
Hydraulic system	74.0 gal. (280.0 L)
Hydraulic tank	46.2 gal. (175.0 L)

All capacities are approximate values. Always refer to the machine's OM for exact refill levels. Check the dipstick, level eye, level plug, etc., to achieve the correct level.

### Hydraulic Cylinders

Boom <sup>1</sup> (2) bore x rod diameter x stroke	5.5" x 3.7" x 57.1" (140 mm x 95 mm x 1450 mm)
Arm <sup>1,2</sup> (1) bore x rod diameter x stroke	5.9" x 4.1" x 65.7" (150 mm x 105 mm x 1670 mm)
Bucket <sup>1</sup> (1) bore x rod diameter x stroke	5.3" x 3.5" x 45.3" (135 mm x 90 mm x 1150 mm)
Bucket (SLR <sup>3</sup> ) <sup>1</sup> (1) bore x rod diameter x stroke	3.7" x 2.6" x 35.4" (95 mm x 65 mm x 900 mm)

<sup>1</sup> Cushion on rod end

<sup>2</sup> Cushion on base end

<sup>3</sup> Applicable to SLR (Super-Long-Reach) machines only

The piston rods and cylinder bodies are made of high-strength steel. A shock-absorbing mechanism is fitted in all cylinders to ensure shock-free operation and extended piston life.

NOTE: Where applicable, dimensions are in accordance with Society of Automotive Engineers (SAE) and ISO standards. Specifications and design are subject to change without notice. All dimensions are given for DEVELON excavators equipped with standard tracks and the standard front as listed. Pictures of DEVELON excavators may show other than standard equipment. All dimensions are shown in inches. Respective metric dimensions are enclosed by parentheses. Rounding may impact specifications. DEVELON equipment is manufactured with a Quality Management System that is in compliance with ISO 9001:2008.

# Dimensions

		Standard Front 31.5" (800 mm) TG Shoe (US20)	Long Arm 33.5" (850 mm) TG Shoe (US30)	Super-Long-Reach 35.4" (900 mm) TG Shoe (US50)
Boom length		20' 5.9" (6245 mm)		32' 9.7" (10000 mm)
Arm length		10' 2.0" (3100 mm)	12' 3.6" (3750 mm)	23' 0.0" (7000 mm)
Bucket size (SAE)		1.66 yd <sup>3</sup> (1.27 m <sup>3</sup> )	1.34 yd <sup>3</sup> (1.03 m <sup>3</sup> )	0.84 yd <sup>3</sup> (0.64 m <sup>3</sup> )
Tail swing radius	A	10' 7.2" (3230 mm)		
Shipping height (boom)	B	10' 8.5" (3265 mm)	11' 4.0" (3455 mm)	11' 0.5" (3365 mm)
Shipping height (hose)	C	11' 0.7" (3370 mm)	11' 8.7" (3575 mm)	11' 4.8" (3475 mm)
Shipping length	D	34' 9.5" (10605 mm)	35' 1.5" (10705 mm)	47' 2.9" (14400 mm)
Shipping width	E	11' 1.8" (3400 mm)	10' 6.0" (3200 mm)	11' 1.8" (3400 mm)
Counterweight clearance*	F	3' 8.1" (1120 mm)		
Cabin height	G	10' 0.0" (3050 mm)		
Upper structure width	H	9' 8.5" (2960 mm)	10' 0.9" (3072 mm)	9' 8.5" (2960 mm)
Cabin height above house	I	2' 9.4" (850 mm)		
Cabin width	J	3' 3.8" (1010 mm)		
Tumbler distance	K	13' 3.0" (4040 mm)		
Overall track length	L	16' 2.5" (4940 mm)		
Undercarriage width	M	11' 1.8" (3400 mm)	11' 3.8" (3450 mm)	11' 5.8" (3500 mm)
Track shoe width	N	31.5" (800 mm)	33.5" (850 mm)	35.4" (900 mm)
Track height*	O	3' 2.2" (970 mm)		
Car body clearance*	P	1' 6.5" (471 mm)	3' 8.1" (1120 mm)	1' 6.5" (471 mm)

\*Without shoe grouser

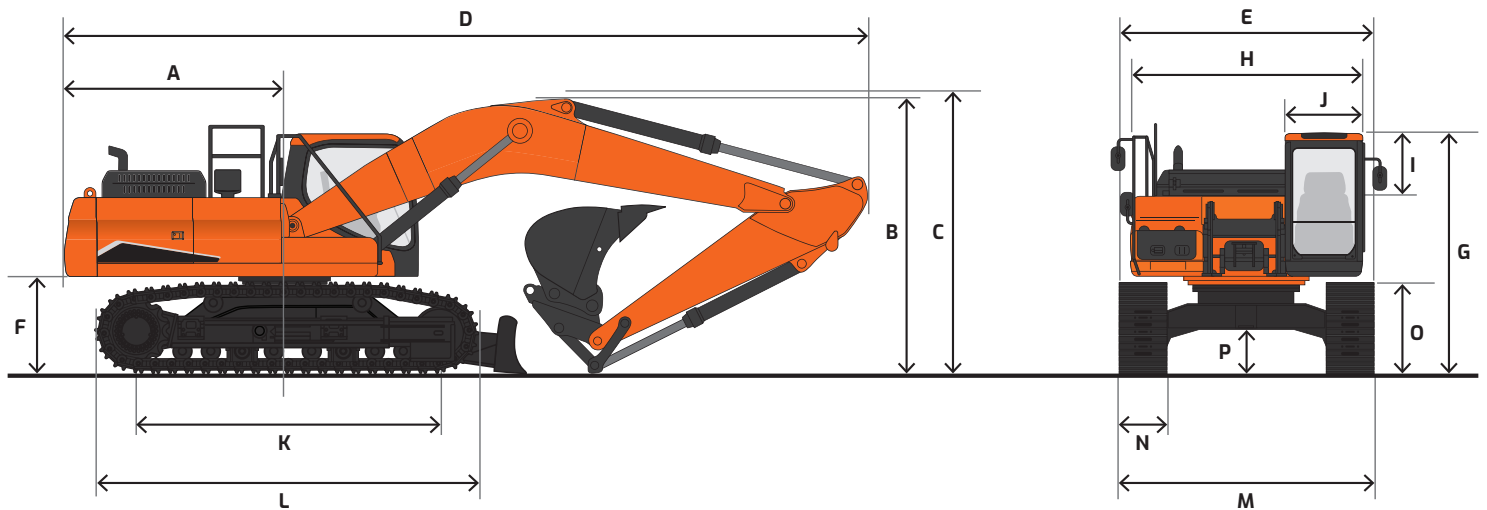

# Working Range

		Standard Front 31.5" (800 mm) TG Shoe (US20)	Long Arm 33.5" (850 mm) TG Shoe (US30)	Super-Long-Reach 35.4" (900 mm) TG Shoe (US50)
Boom length		20' 5.9" (6245 mm)		32' 9.7" (10000 mm)
Arm length		10' 2.0" (3100 mm)	12' 3.6" (3750 mm)	23' 0.0" (7000 mm)
Bucket size (SAE)		1.66 yd <sup>3</sup> (1.27 m <sup>3</sup> )	1.34 yd <sup>3</sup> (1.03 m <sup>3</sup> )	0.84 yd <sup>3</sup> (0.64 m <sup>3</sup> )
Counterweight		13889 lb. (6300 kg)		
Track type		Fixed		
Max. digging reach	A	35' 2.4" (10725 mm)	36' 10.5" (11240 mm)	57' 5.4" (17510 mm)
Max. digging reach (ground)	B	34' 6.6" (10530 mm)	36' 3.2" (11055 mm)	57' 0.6" (17390 mm)
Max. digging depth	C	23' 11.6" (7305 mm)	26' 0.8" (7945 mm)	45' 2.5" (13780 mm)
Max. loading height	D	23' 10.6" (7280 mm)	24' 2.9" (7390 mm)	39' 4.0" (11990 mm)
Min. loading height	E	9' 0.3" (2750 mm)	6' 11.1" (2110 mm)	7' 8.3" (2345 mm)
Max. digging height	F	33' 10.5" (10325 mm)	34' 1.6" (10405 mm)	46' 6.9" (14195 mm)
Max. bucket pin height	G	29' 1.6" (8880 mm)	29' 5.7" (8985 mm)	43' 3.9" (13205 mm)
Max. vertical wall depth	H	20' 1.14" (6125 mm)	15' 7.8" (4770 mm)	38' 0.3" (11590 mm)
Max. radius vertical	I	22' 5.28" (6840 mm)	27' 6.3" (8390 mm)	35' 9.1" (10900 mm)
Max. depth to 8' line	J	23' 3.9" (7110 mm)	25' 5.3" (7755 mm)	44' 9.2" (13645 mm)
Min. radius to 8' line	K	9' 10.1" (3000 mm)	9' 7.0" (2920 mm)	16' 10.6" (5150 mm)
Min. digging reach	L	2' 0.4" (620 mm)	0' -11.0" (-280 mm)	3' 9.7" (1160 mm)
Min. swing radius	M	13' 3.0" (4040 mm)	13' 3.6" (4055 mm)	20' 0.9" (6120 mm)
Bucket angle (DEG)	d	175°		169°
Digging force, bucket*	ISO	44092 lbf. (20000 kgf)	44061.1 lbf. (19986 kgf)	23148.3 lbf. (10500 kgf)
Digging force, arm*		30643.9 lbf. (13900 kgf)	27425.2 lbf. (12440 kgf)	16534.5 lbf. (7500 kgf)
Operating weight		73413 lb. (33300 kg)	74075 lb. (33600 kg)	74956 lb. (34000 kg)
Ground pressure		6.8 psi (0.48 kg/cm <sup>2</sup> )	6.5 psi (0.46 kg/cm <sup>2</sup> )	6.1 psi (0.43 kg/cm <sup>2</sup> )

\*With power boost ON

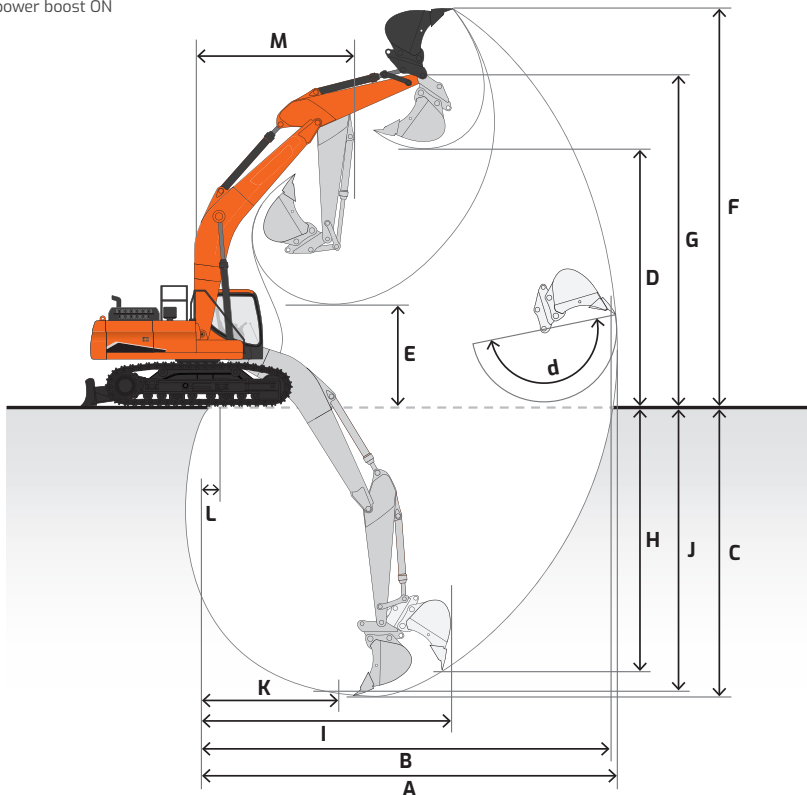















# Lifting Capacity

 Rating over front     Rating over side or 360°

## DX300LC-7 US20

Boom: 20' 5.9" (6245 mm) | Arm: 10' 2.0" (3100 mm) | Counterweight: 13889 lb. (6300 kg) | Shoes | Bucket: None | Unit: lb. (kg)

A (ft. or m) B (ft. or m)	5' (1.5 m)		10' (3.0 m)		15' (4.5 m)		20' (6.0 m)		25' (7.5 m)		30' (9.0 m)		Max. Reach			
															A	
25' (7.5 m)														* 11810 (* 5360)	* 11810 (* 5360)	23.84' (7.27 m)
20' (6.0 m)							* 14970 (* 6790)	* 14970 (* 6790)	* 14760 (* 6700)	* 14760 (* 6700)				* 11350 (* 5150)	* 11350 (* 5150)	26.89' (8.19 m)
15' (4.5 m)					* 20850 (* 9460)	* 20850 (* 9460)	* 17430 (* 7900)	* 17430 (* 7900)	* 15810 (* 7170)	14700 (6670)				* 11370 (* 5160)	* 11370 (* 5160)	28.78' (8.77 m)
10' (3.0 m)					* 27600 (* 12520)	* 27600 (* 12520)	* 20650 (* 9370)	19660 (8920)	* 17460 (* 7920)	14180 (6430)	* 13000 (* 5900)	10720 (4860)		* 11790 (* 5350)	9570 (4800)	29.75' (9.07 m)
5' (1.5 m)					* 33190 (* 15060)	28110 (12750)	* 23730 (* 10760)	18710 (8490)	* 19180 (* 8700)	13670 (6200)	* 14820 (* 6720)	10490 (4760)		* 12650 (* 5740)	9290 (4680)	29.87' (9.10 m)
Ground Level					* 35910 (* 16290)	27940 (12360)	* 25870 (* 11730)	18080 (8200)	* 20500 (* 9300)	13290 (6030)				* 14110 (* 6400)	9460 (4770)	29.17' (8.89 m)
-5' (-1.5 m)	* 19060 (* 8650)	* 19060 (* 8650)	* 27140 (* 12310)	* 27140 (* 12310)	* 36240 (* 16440)	27030 (12260)	26690 (12110)	17800 (8080)	20880 (9470)	13120 (5950)				* 16620 (* 7540)	10200 (5130)	27.57' (8.4 m)
-10' (-3.0 m)	* 30940 (* 14030)	* 30940 (* 14030)	* 41880 (* 19000)	* 41880 (* 19000)	* 34570 (* 15680)	27230 (12350)	* 25880 (* 11740)	17870 (8100)	* 19830 (* 8990)	13260 (6010)				* 19470 (8830)	11850 (5930)	24.89' (7.59 m)
-15' (-4.5 m)			* 41950 (* 19030)	* 41950 (* 19030)	* 30200 (* 13700)	27870 (12640)	* 22220 (* 10080)	18370 (8330)						* 20530 (* 9310)	15790 (7780)	20.75' (6.32 m)

A Distance from center of rotation  
B Height

NOTE: Lifting capacities are in compliance with SAE 1097 and ISO 10567. Machine in lifting mode with power boost turned on. Load point is the end of the arm. Rated loads shown do not exceed 75% of minimum tipping loads or 87% of hydraulic capacities. Rated loads marked with an asterisk (\*) are limited by hydraulic capacities. The least stable position is over the side. The total mass of machine includes the mass of the boom, arm, counterweight, all operating fluids and 165 lb. (75 kg) operator.

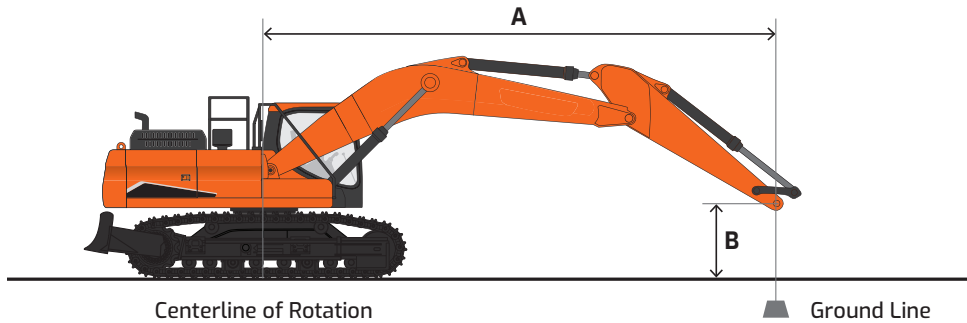

























# Lifting Capacity

Rating over front  Rating over side or 360°

## DX300LC-7 U550

Boom: 32' 9.7" (10000 mm) | Arm: 23' 0.0" (7000 mm) | Counterweight: 13889 lb. (6300 kg) | 135.4" (900 mm) TG Shoes | Bucket: None | Unit: lb (kg)

A B (ft. or m) / (ft. or m)	5' (1.5 m)		10' (3.0 m)		15' (4.5 m)		20' (6.0 m)		25' (7.5 m)		30' (9.0 m)		35' (10.5 m)		40' (12.0 m)		45' (13.5 m)		50' (15.0 m)		Max. Reach					
																										
45' (13.5 m)																						* 2910 (1320)	* 2910 (1320)	37.65' (11.48 m)		
40' (12.0 m)																							* 2590 (1170)	* 2590 (1170)	42.17' (12.85 m)	
35' (10.5 m)																							* 2460 (1120)	* 2460 (1120)	45.57' (13.89 m)	
30' (9.0 m)																							* 2390 (1090)	* 2390 (1090)	48.26' (14.71 m)	
25' (7.5 m)																							* 2380 (1080)	* 2380 (1080)	50.32' (15.34 m)	
20' (6.0 m)																							* 2400 (1090)	* 2400 (1090)	51.87' (15.79 m)	
15' (4.5 m)																							* 2460 (1120)	* 2460 (1120)	52.82' (16.1 m)	
10' (3.0 m)																							* 2570 (1160)	* 2570 (1160)	53.35' (16.26 m)	
5' (1.5 m)																							* 2720 (1230)	* 2720 (1230)	53.41' (16.28 m)	
Ground Level																							* 2920 (1320)	* 2920 (1320)	53.03' (16.16 m)	
-5' (-1.5 m)	* 9120 (4140)	* 10230 (4640)	* 10230 (4640)	* 10230 (4640)	* 10230 (4640)	* 10230 (4640)	* 10230 (4640)	* 10230 (4640)	* 10230 (4640)	* 10230 (4640)	* 10230 (4640)	* 10230 (4640)	* 10230 (4640)	* 10230 (4640)	* 10230 (4640)	* 10230 (4640)	* 10230 (4640)	* 10230 (4640)	* 10230 (4640)	* 10230 (4640)	* 10230 (4640)	* 10230 (4640)	* 10230 (4640)	* 10230 (4640)	* 10230 (4640)	52.17' (15.9 m)
-10' (-3.0 m)	* 11260 (5100)	* 12620 (5720)	* 12620 (5720)	* 12620 (5720)	* 12620 (5720)	* 12620 (5720)	* 12620 (5720)	* 12620 (5720)	* 12620 (5720)	* 12620 (5720)	* 12620 (5720)	* 12620 (5720)	* 12620 (5720)	* 12620 (5720)	* 12620 (5720)	* 12620 (5720)	* 12620 (5720)	* 12620 (5720)	* 12620 (5720)	* 12620 (5720)	* 12620 (5720)	* 12620 (5720)	* 12620 (5720)	* 12620 (5720)	50.82' (15.49 m)	
-15' (-4.5 m)	* 13520 (6130)	* 15130 (6860)	* 15130 (6860)	* 15130 (6860)	* 15130 (6860)	* 15130 (6860)	* 15130 (6860)	* 15130 (6860)	* 15130 (6860)	* 15130 (6860)	* 15130 (6860)	* 15130 (6860)	* 15130 (6860)	* 15130 (6860)	* 15130 (6860)	* 15130 (6860)	* 15130 (6860)	* 15130 (6860)	* 15130 (6860)	* 15130 (6860)	* 15130 (6860)	* 15130 (6860)	* 15130 (6860)	* 15130 (6860)	48.94' (14.92 m)	
-20' (-6.0 m)	* 15920 (7220)	* 17860 (8100)	* 17860 (8100)	* 17860 (8100)	* 17860 (8100)	* 17860 (8100)	* 17860 (8100)	* 17860 (8100)	* 17860 (8100)	* 17860 (8100)	* 17860 (8100)	* 17860 (8100)	* 17860 (8100)	* 17860 (8100)	* 17860 (8100)	* 17860 (8100)	* 17860 (8100)	* 17860 (8100)	* 17860 (8100)	* 17860 (8100)	* 17860 (8100)	* 17860 (8100)	* 17860 (8100)	* 17860 (8100)	46.44' (14.15 m)	
-25' (-7.5 m)	* 18520 (8400)	* 20900 (9480)	* 20900 (9480)	* 20900 (9480)	* 20900 (9480)	* 20900 (9480)	* 20900 (9480)	* 20900 (9480)	* 20900 (9480)	* 20900 (9480)	* 20900 (9480)	* 20900 (9480)	* 20900 (9480)	* 20900 (9480)	* 20900 (9480)	* 20900 (9480)	* 20900 (9480)	* 20900 (9480)	* 20900 (9480)	* 20900 (9480)	* 20900 (9480)	* 20900 (9480)	* 20900 (9480)	* 20900 (9480)	43.26' (13.19 m)	
-30' (-9.0 m)	* 21990 (9700)	* 24400 (11070)	* 24400 (11070)	* 24400 (11070)	* 24400 (11070)	* 24400 (11070)	* 24400 (11070)	* 24400 (11070)	* 24400 (11070)	* 24400 (11070)	* 24400 (11070)	* 24400 (11070)	* 24400 (11070)	* 24400 (11070)	* 24400 (11070)	* 24400 (11070)	* 24400 (11070)	* 24400 (11070)	* 24400 (11070)	* 24400 (11070)	* 24400 (11070)	* 24400 (11070)	* 24400 (11070)	* 24400 (11070)	39.19' (11.95 m)	
-35' (-10.5 m)	* 28580 (12960)	* 28580 (12960)	* 28580 (12960)	* 28580 (12960)	* 28580 (12960)	* 28580 (12960)	* 28580 (12960)	* 28580 (12960)	* 28580 (12960)	* 28580 (12960)	* 28580 (12960)	* 28580 (12960)	* 28580 (12960)	* 28580 (12960)	* 28580 (12960)	* 28580 (12960)	* 28580 (12960)	* 28580 (12960)	* 28580 (12960)	* 28580 (12960)	* 28580 (12960)	* 28580 (12960)	* 28580 (12960)	* 28580 (12960)	33.93' (10.34 m)	
-40' (-12.0 m)																							* 9620 (4360)	* 9620 (4360)	26.6' (8.17 m)	

A Distance from center of rotation  
B Height

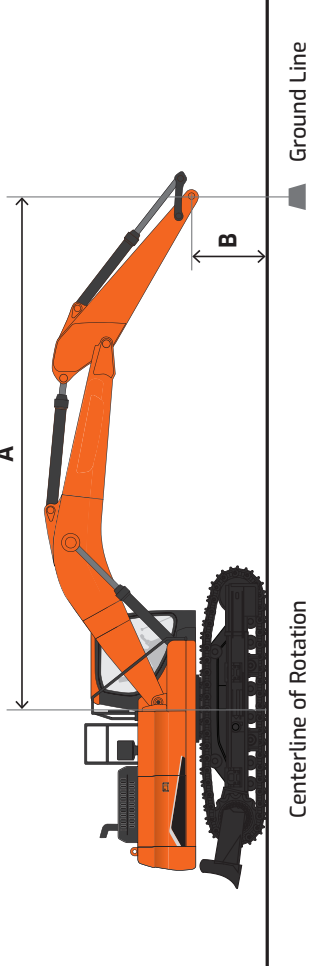

NOTE: Lifting capacities are in compliance with SAE 1037 and ISO 10567. Machine in lifting mode with power boost turned on. Load point is the end of the arm. Rated loads shown do not exceed 75% of minimum tipping loads or 87% of hydraulic capacities. Rated loads marked with an asterisk (\*) are limited by hydraulic capacities. The least stable position is over the side. The total mass of machine includes the mass of the boom, arm, counterweight, all operating fluids and 165 lb. (75 kg) operator.

Centerline of Rotation

Ground Line

# Standard & Optional Equipment

■ Standard • Optional

## Engine

Emissions (EPA), T4f	■
High-pressure common-rail (HPCR)	■
Variable geometry (VGT)	■
Cooled exhaust gas recirculation (CEGR)	■
Exhaust brake	■
Diesel oxidation catalyst (DOC)	■
Selective catalytic reduction (SCR)	■
Diesel exhaust fluid (DEF)	■
Fuel filter with water separator	■
Coolant expansion tank	■
Dual element dry-type air filter with evacuator	■
Precleaner	■
Electronic engine control (ECU)	■
Auto idle	■
Auto shutdown (time-adjustable)	■
Overheat & low oil pressure engine protection	■
Block heater (110 V)	■
Water separator with heater	■
Fuel filler pump	•

## Hydraulic

Mechatronics Design	■
Variable axial piston main pump (tandem)	■
Cross-sensing pump control	■
Pilot-operated control valves	■
Gear pilot pump	■
Smart Power Control (SPC)	■
Variable-speed hydraulic cooling fan	■
Axial piston swing motor	■
Spring-applied hydraulic release brake	■
Axial piston travel motor (high/low, auto)	■
Auxiliary hydraulics, one- & two-way piping	■
Auxiliary hydraulics, tilt/rotate piping	•
Adjustable auxiliary flow & pressure, 10 presets	■
Intelligent floating boom	•
Boom & arm lock valves	•

## Controls

Joystick controls	■
Pattern control change valve (SAE, ISO)	■
Joystick attachment control, switches/buttons - Right (one-way, two-way, power boost) - Left (tilt/rotate, horn, one-touch decel)	■
Foot pedal attachment control	■
Control stands - Height adjustable - Sliding (fore/aft) - Tilting armrests	■
Engine speed control dial	■
Travel pedals with hand levers	■
Straight travel pedal	•
Switches, console-mounted - Starter button switch - Travel speed selector - Work light - Auxiliary mode switch	■
Emergency stop switch	■
Power modes (P+, P, S, E)	■
Work modes (digging, lifting, breaker, shear)	■
Smart Power Control (SPC)	■
Jog dial display control	■
Wiper control panel	■
Audio control panel	■

## Cabin

Steel, all-weather & sound-suppressed	■
ROPS (ISO 12117-2:2008)	■
Viscous mount with spring reinforcement	■
Front window with wiper/washer	■
Tinted safety glass	■
Skylight top hatch with sun screen	■
Front window with sun screen	■
Pull-up type top front window	■
Removable lower front window with storage behind seat	■
Wiper, lower window	■
Adjustable sliding side door window	■
Defrost, front window	■
Lockable doors	■
Seat - Heated - Air-suspension - 2" (51 mm) seat belt - Adjustable height & recline - Adjustable fore/aft - Adjustable armrests	■
Leatherette seat - Heating & cooling - Air-suspension - 2" (51 mm) seat belt - Adjustable height & recline - Adjustable fore/aft - Adjustable armrests	•
Control stands - Height adjustable - Mounted to seat base	■
Storage for operator's manuals	■
Mirrors	■
Fully automatic HVAC with radiant energy photo sensor	■
8" multi-function LCD interactive display monitor	■
Cigarette lighter	■
Digital Bluetooth® & MP3 radio with cell phone integration	■
Speakers (2)	■
Antenna, roof-mounted	■
Emergency breakout tool	■
Hot/cold beverage compartment	■
Power socket, 12 V & 24 V	■
Cup holder	■
Interior light	■
Coat hanger	■
Rain shield	•
FOG guard	•
Front window guard	•

## Electrical

System voltage – 24 V	■
Alternator – 24 V, 80 A	■
2 x 12 V batteries, 150 AH reserve capacity, 1300 CCA	■
Blade-type fuse panel	■
Main circuit breaker	■
Lights, work (LED): machine (2), boom (2)	■
Lights, work (halogen): cabin (2)	•
Lights, work (halogen): cabin front (4), rear (2)	•
Rotating beacon	■
Overload warning alarm	•
Hour meter	■
Engine restart prevention system	■
Rearview camera	■
Side view camera, right side	■
Around view camera	•
Microphone & speaker	•
Ultrasonic sensor	•
Laptop service port	■
Self-diagnostics system	■
Smart Key (remote ignition key)	■
MY DEVELON (telematics)	■

## Display Monitor & Warnings

Indicators - Power modes - Work modes - User/Service menu	■
Gauges - Fuel level - DEF level - Engine coolant temperature - Hydraulic oil temperature - Engine rpm - Battery voltage - Hydraulic pump pressure - ECO - Digital clock - Trip meter - Hour meter - Fuel consumption	■
Warning & indicator lights - Seat belt - Error code - SCR warning - Check engine - Engine oil pressure - Engine pre-heat engaged - Radiator coolant level & temperature - Air filter - Fuel level - DEF level – low - Water in fuel - Battery charge - Work lights on - Hydraulic oil temperature - Hydraulic charge pressure - Hydraulic pilot filter - Hydraulic return filter	■
Swing alarm	■
Travel alarm	■
Buzzer - Engine oil pressure - Coolant temperature	■

## Undercarriage

Fixed track width	■
Track guards & chains with adjusters	■
Track rollers, upper	2
Track rollers, lower	9
In-shoe motor protection	■
Shoes, triple grouser – 700 mm	•
Shoes, triple grouser – 800 mm	■
Shoes, triple grouser – 900 mm	•

## Frame

Counterweight, fixed	■
----------------------	---

## Other

Centralized lubrication - Boom - Arm - Swing	■
Handrails & service platforms	■
Skid-resistant steps & service platforms	■
Manuals - Operation & Maintenance - AEM Safety Manual	■
MY DEVELON 3-year subscription (telematics)	■
Vandalism protection - Lockable panels - Lockable fluid fill points - Anti-theft protection (password)	■
Vandalism window cover mount	•
Air compressor	•

Certain specification(s) are based on engineering calculations and are not actual measurements. Specification(s) are provided for comparison purposes only and are subject to change without notice. Specification(s) for your individual DEVELON equipment will vary based on normal variations in design, manufacturing, operating conditions, and other factors. Pictures of DEVELON units may show other than standard equipment.

# Powered by Innovation

# DEVELON

A brand of HD Hyundai Infracore.

[na.develon-ce.com/dx300lc-7](http://na.develon-ce.com/dx300lc-7)

DX300LC-7 Crawler Excavator Spec Sheet  
Printed in the U.S.A.  
23906\_002\_D092724

©2024 HD Hyundai Infracore. All rights reserved.